

INSTALLATION INSTRUCTIONS

HDX GRILLE GUARD



APPLICATION: 2015-2022 Ford Transit 150/250/350

PART NUMBER: 57-4055

CONTENT			
ITEM	QUANTITY	DESCRIPTION	TOOLS NEEDED
1	1	GRILLE GUARD	13MM SOCKET
2	1	DRIVER LOWER MOUNTING BRACKET	13MM WRENCH
3	1	PASSENGER LOWER MOUNTING BRACKET	15MM SOCKET
4	2	SPACER	15MM WRENCH
5	1	DRIVER UPPER SUPPORT BRACKET	18MM SOCKET
6	1	PASSENGER UPPER SUPPORT BRACKET	18MM WRENCH
7	1	DRIVER LOWER SUPPORT BRACKET	RATCHET
8	1	PASSEGER LOWER SUPPORT BRACKET	TORQUE WRENCH
9	2	M10 BUTTON HEAD BOLT	2" HOLE SAW
10	2	M10 BELLVILLE WASHER	PRY TOOL
11	2	M10 SERRATED FANGE NIUT (GLOSSY)	
12	4	M12 BELLVILLE WASHER	
13	4	M12 BUTTON HEAD BOLT	
14	4	M12 SERRATED FLANGE NUT	
15	2	LONG M12 HEX HEAD BOLT	
16	2	SHORT M12 HEX HEAD BOLT	
17	8	M12 FLAT WASHER	
18	4	M12 SPLIT LOCK WASHER	
19	4	M12 HEX NUT	
20	6	M10 SERRATED FLANGE NUT (DULL)	
21	4	M10 SERRATED FLANGE BOLT	

ANTI-SEIZE LUBRICANT MUST BE USED ON ALL STAINLESS STEEL FASTENERS TO PREVENT THREAD DAMAGE AND GALLING

PROCEDURE

1. Remove contents from box, verify if all parts listed are present and free from damage.
Carefully read and understand all instructions before attempting installation.
Failure to identify damage before installation could lead to a rejection of any claim.

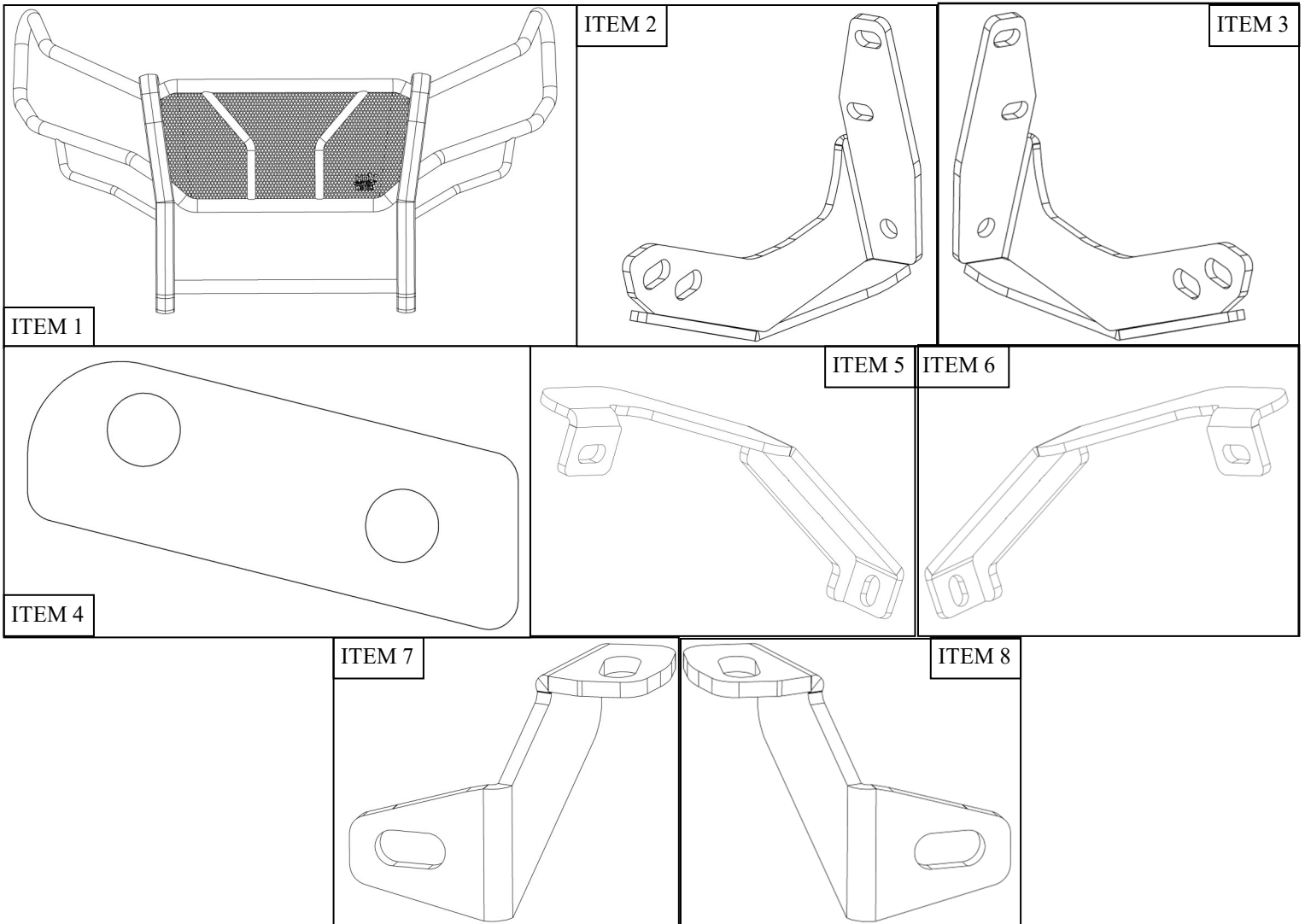

2. Start by removing the front fender trim pieces shown by removing two factory clips. Repeat for both sides. See **Figure 1** for reference.
3. Remove the single bolt on each side inside the fender well. See **Figure 2** for reference



4. Remove the headlights on both sides by removing the two bolts shown in **Figure 3**. unplug the headlights and tilt the headlights back and forth gently to release the plastic clip at the bottom of the headlights in order to remove them.
5. Unclip the bumper retaining clip at the bottom of the headlight bezel. Repeat on the opposite side. See **Figure 4** for reference.
6. Remove the plastic clips and fasteners along the top side of the bumper. Also remove the 10MM fasteners along the bottom of the front bumper. See **Figure 5** for reference.

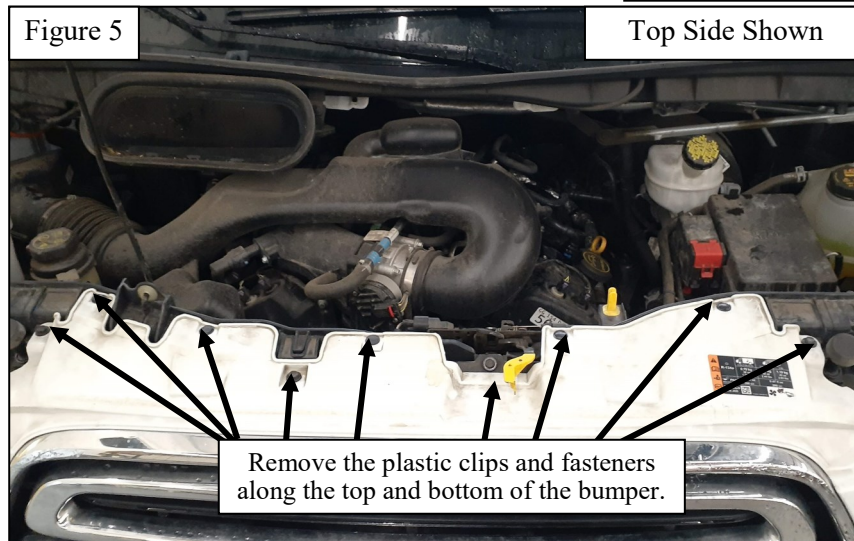
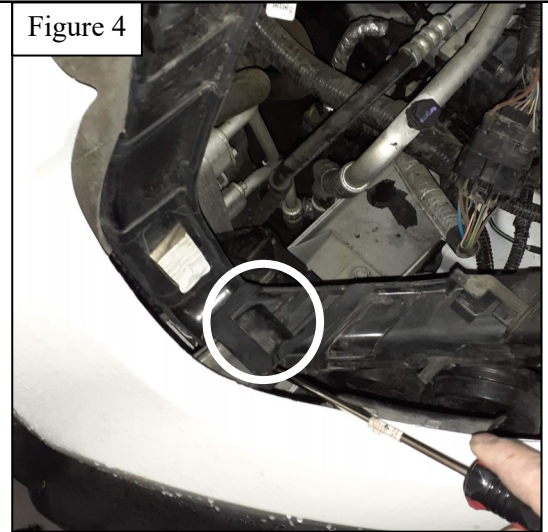
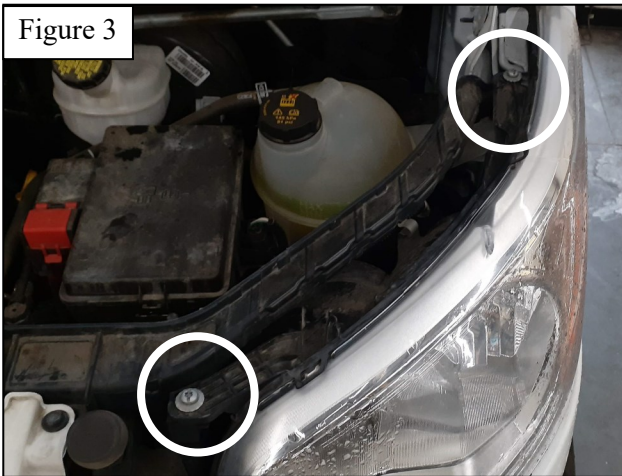

7. Remove the license plate and factory license plate holder. Remove the two bolts and carefully pull off the bumper assembly. See **Figure 6 & 7** for reference. **Note:** Make sure any wiring connectors secured to the bumper are unplugged prior to removal.

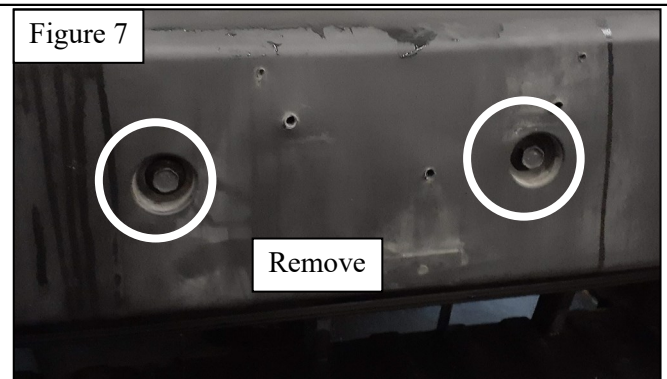
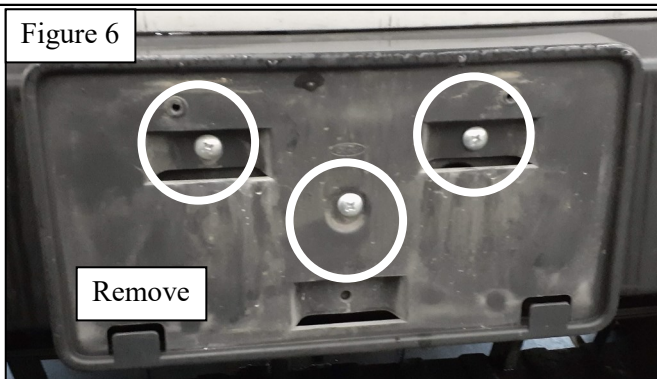

8. Remove the factory air duct **Shown in Figure 8**. This will not be reused. (Do this for both passenger and driver side.)

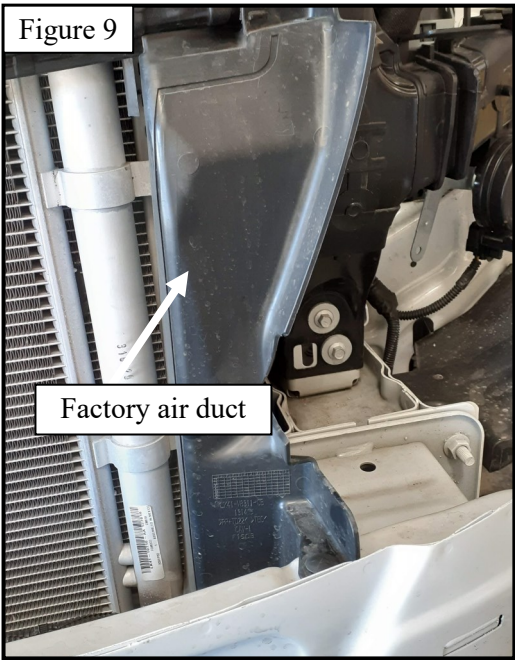
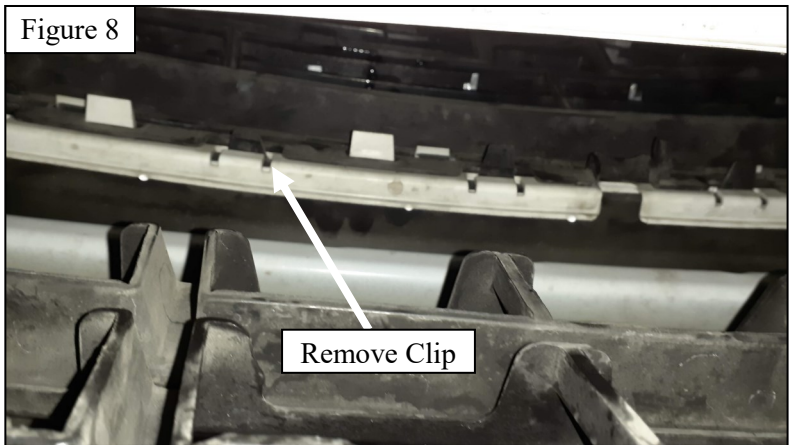

TRIMMING INSTRUCTIONS

- 9. **For model years 2015-2019:** Use the larger provided templates to cut out the bumper See **Figure 10**
- 10. **For model years 2020-2021:** Use the smaller provided templates to cut out the bumper See **Figure 11**
- Align templates as shown below on both driver and passenger sides.
- Cut out the section shown on the template with a 2" hole saw.

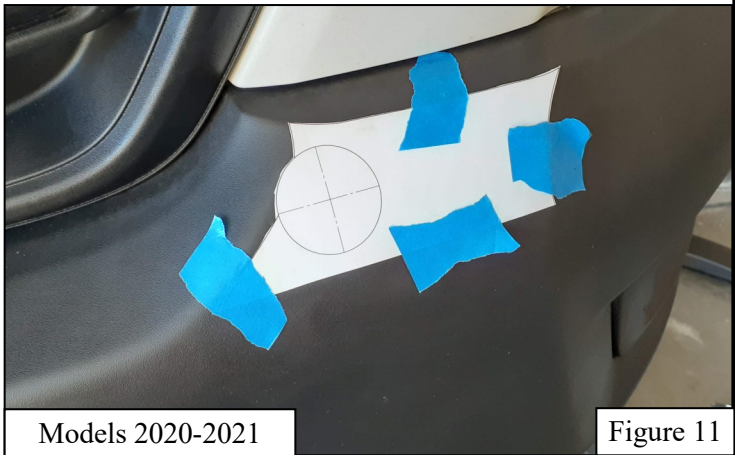
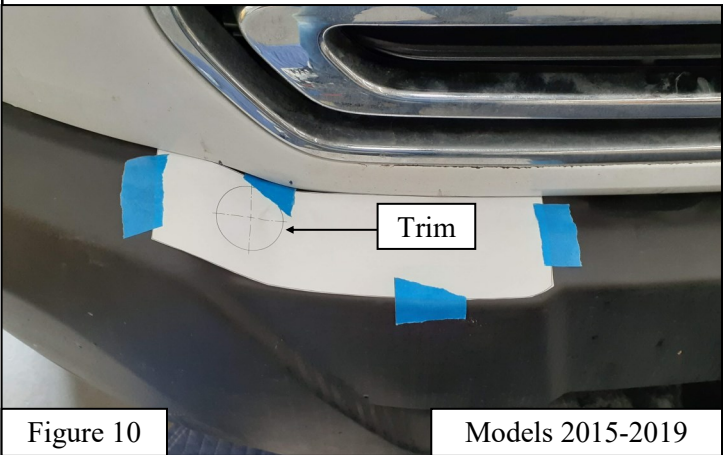

11. After trimming the bumper, reinstall on the vehicle.
12. Using the supplied M10 hardware, install the upper support brackets to the front of the vehicle frame using the upper mounting locations. See **Figure 12 & 13** for reference.

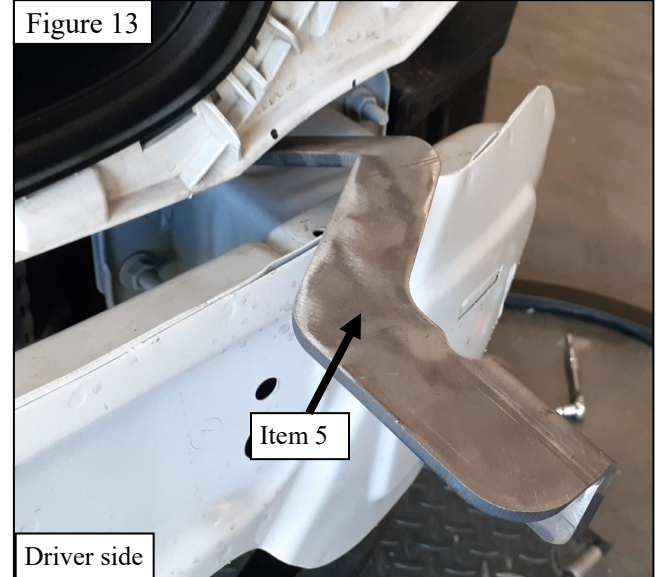
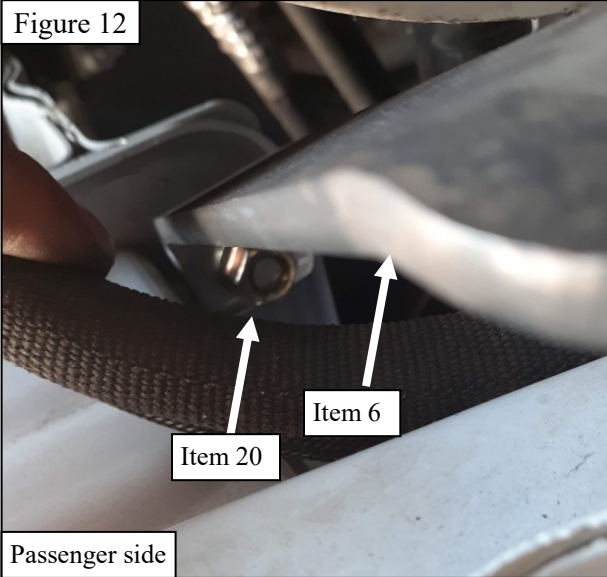

13. Using the supplied M10 and M12 hardware, loosely assemble the lower mounting bracket, lower support bracket, and spacer to the vehicle's frame on each side. See **Figure 14 & 15** for reference.

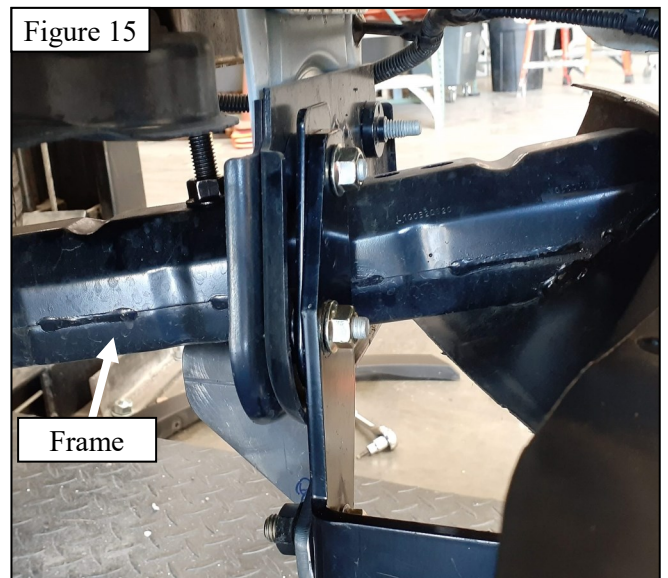
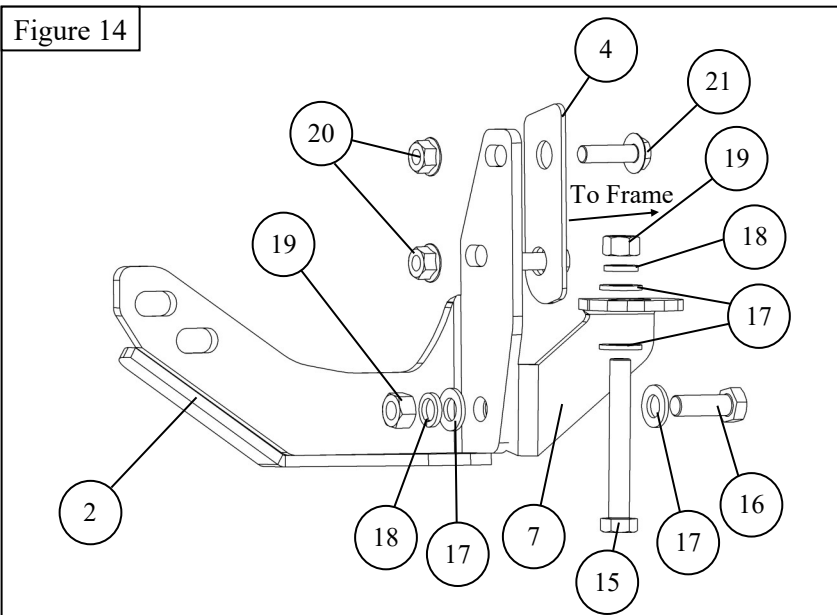

14. Using the supplied M10 and M12 hardware, loosely assemble the grille guard to the mounting brackets. See Figure 16 for reference.
15. Adjust as needed and torque all hardware as specified: M10 to 35-40 ft-lbs., M12 to 55-60 ft-lbs.

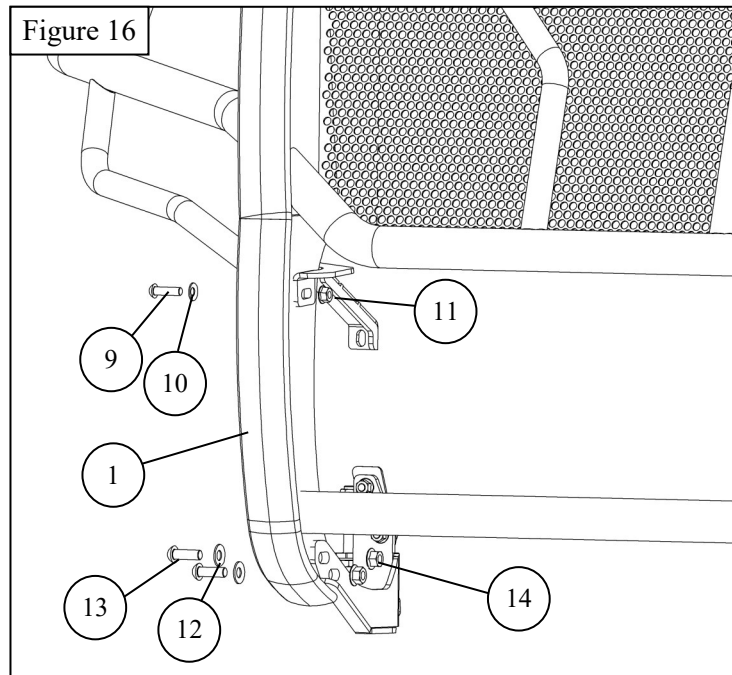

CARE INSTRUCTIONS

- REGULAR WAXING IS RECOMMENDED. DO NOT USE ANY TYPE OF POLISH OR WAX THAT MAY CONTAIN ABRASIVES.
- STAINLESS STEEL PRODUCTS CAN BE CLEANED WITH MILD SOAP AND WATER. STAINLESS STEEL POLISH SHOULD BE USED TO POLISH SMALL SCRATCHES.
- GLOSS BLACK FINISHES SHOULD BE CLEANED WITH MILD SOAP AND WATER.

WESTIN Westin Automotive Products, Inc.
320 W. Covina Blvd
San Dimas, Ca. 91773

Thank you for choosing Westin products
for additional installation assistance please call
Customer Service (800) 793-7846

www.westinautomotive.com

DATE: 01/24/22



WARNING



Failure to follow these instructions could lead to death, personal injury, and / or property damage.

Failure to follow these instructions could lead to death, personal injury, and / or property damage.

FASTENERS:

All Westin supplied fasteners must be utilized and installed in accordance with the installation instructions and apply torque to the specifications as defined. **DOUBLE CHECK ALL FASTENERS BEFORE INITIAL USE, AND PERIODICALLY IN THE FUTURE TO ENSURE PROPER FUNCTION AND SAFETY.**

DRILLING:

Most Westin products do not require drilling for installation. If drilling is defined as required, use caution when drilling a vehicle. **FAILURE TO REVIEW AN AREA TO BE DRILLED MAY RESULT IN PERSONAL INJURY AND/OR INJURY TO OTHERS AS WELL AS VEHICLE DAMAGE.**

EYE PROTECTION:

ALWAYS WEAR SAFETY GLASSES OR GOGGLES DURING THE INSTALLATION PROCESS TO AVOID PERSONAL INJURY.

MAXIMUM TOWING/CARRYING CAPACITY: (if applicable)

The Westin Receiver Hitches will have a visible tow rating label affixed directly on the product. User should never exceed the vehicle manufacturers maximum tow and weight rating regardless of the capacity of the hitch. **FAILURE TO FOLLOW THESE GUIDELINES WILL VOID THE WESTIN WARRANTY AND MAY RESULT IN PERSONAL INJURY AND/OR INJURY TO OTHERS AS WELL AS VEHICLE DAMAGE.**

FOR CALIFORNIA RESIDENTS ONLY-PROP 65 WARNING:

Some products may contain chemicals such as DEHP, which can cause cancer, birth defects or other reproductive harm. For more info go to www.p65warnings.ca.gov



Westin Automotive Products, Inc.
320 W. Covina Blvd
San Dimas, Ca. 91773