

INSTALLATION INSTRUCTIONS

HDX MODULAR GRILLE GUARD



APPLICATION:

2020-2024 Chevrolet Silverado 2500/3500 (Excl. w/Sensors)

PART NUMBER:

57-23990, 57-23995

ITEM	QUANTITY	DESCRIPTION	TOOLS NEEDED
1	1	HDX GRILLE GUARD BASE	RATCHET
2	1	HDX DRIVER WING	16MM SOCKET
3	1	HDX PASSENGER WING	17MM SOCKET
4	1	LOWER DRIVER MOUNTING BRACKET	18MM SOCKET
5	1	LOWER PASSENGER MOUNTING BRACKET	16MM WRENCH
6	1	DRIVER INSIDE SUPPORT BRACKET	17MM WRENCH
7	1	PASSENGER INSIDE SUPPORT BRACKET	18MM WRENCH
8	1	DRIVER UPPER SUPPORT STRAP "A"	TORQUE WRENCH
9	1	PASSENGER UPPER SUPPORT STRAP "A"	CUTTING TOOL
10	2	SHORT M12 HEX HEAD BOLT	
11	4	LONG M12 HEX HAD BOLT	
12	6	M12 SPLIT LOCK WASHER	
13	12	M12 FLAT WASHER	
14	6	M12 HEX NUT	
15	2	M10 HEX SOCKET BUTTON HEAD BOLT	
16	2	M10 BELLVILLE WASHER	
17	2	M10 SERRATED FLANGE NUT	
18	6	M12 HEX SOCKET BUTTON HEAD BOLT	
19	6	M12 SERRATED FLANGE NUT	
20	6	M12 BELLVILLE WASHER	
21	8	M8 HEX SOCKET BUTTON HEAD BOLT	
22	8	M8 BELLVILLE WASHER	
23	8	M8 SERRATED FLANGE NUT	
24	1	DRIVER CUTTING TEMPLATE "B"	
25	1	PASSENGER CUTTING TEMPLATE "B"	
26	1	DRIVER SUPPORT BRACKET "B"	
27	1	PASSENGER SUPPORT BRACKET "B"	
28	1	DRIVER CUTTING TEMPLATE "A"	
29	1	PASSENGER CUTTING TEMPLATE "A"	

ANTI-SEIZE LUBRICANT MUST BE USED ON ALL STAINLESS STEEL FASTENERS TO PREVENT THREAD DAMAGE AND GALLING.



Westin Automotive Products, Inc.
320 W. Covina Blvd
San Dimas, Ca. 91773

Thank You for choosing Westin products
For Additional installation assistance please call
Customer service (800) 793-7846
www.westinautomotive.com

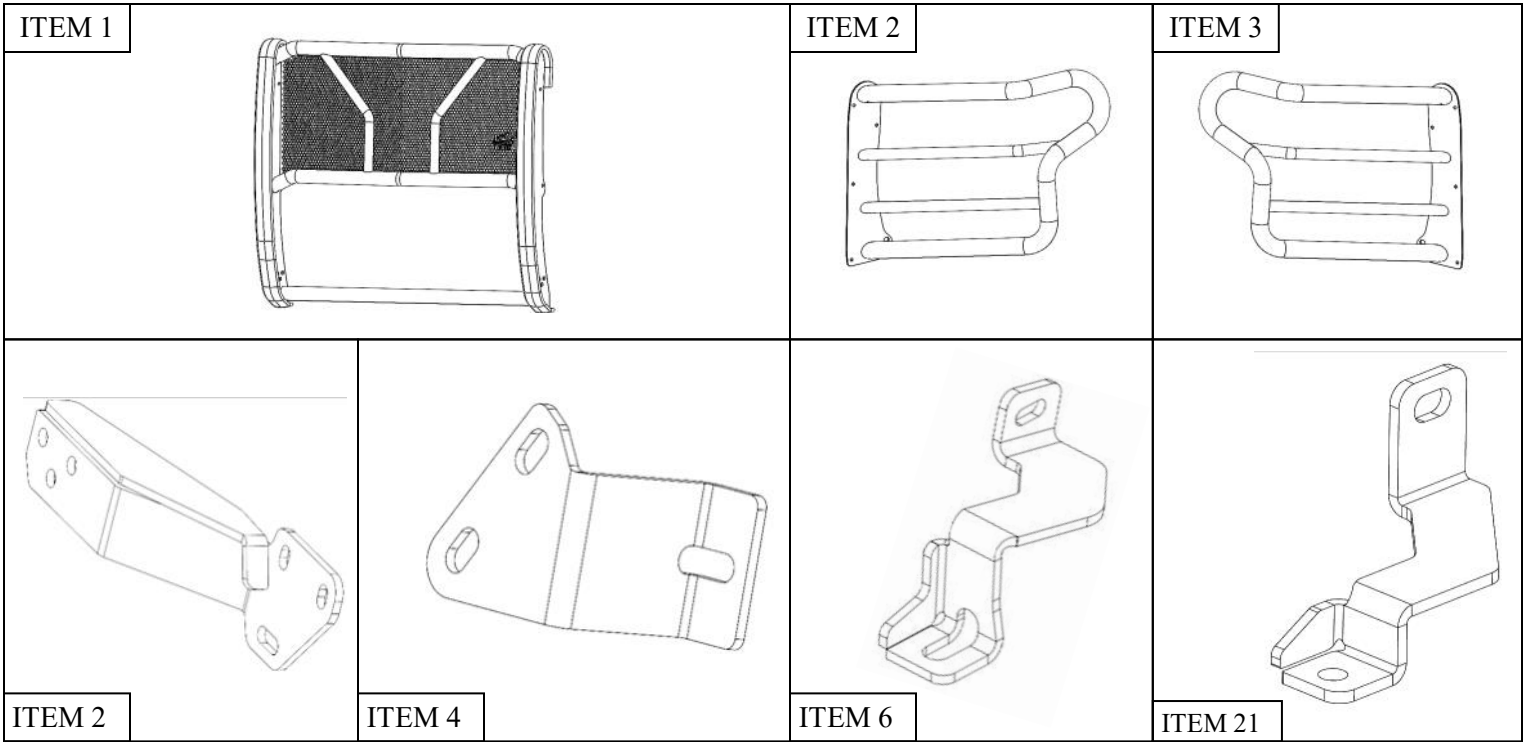

PROCEDURE

1. Remove contents from box, verify if all parts listed are present and free from damage.
Carefully read and understand all instructions before attempting installation.
Failure to identify damage before installation could lead to a rejection of any claim.

2. Open the hood of the vehicle and remove the plastic cover at the front using a pry tool. See **Figure 1** for reference.
3. Remove the four bolts holding the grille in place. See **Figure 2** for reference.
4. Remove 2 bolts attaching wheel well cover to filler panel. See **Figure 3** for reference.

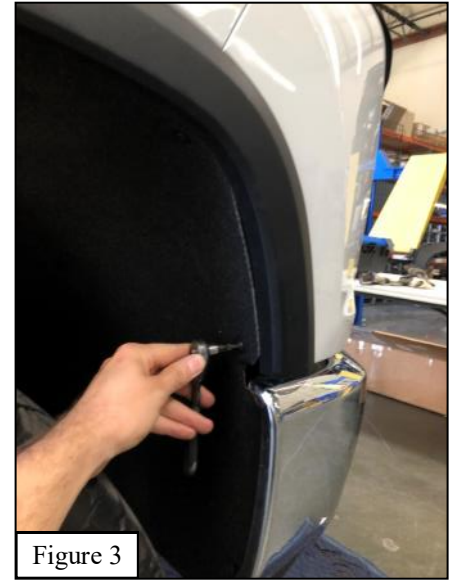
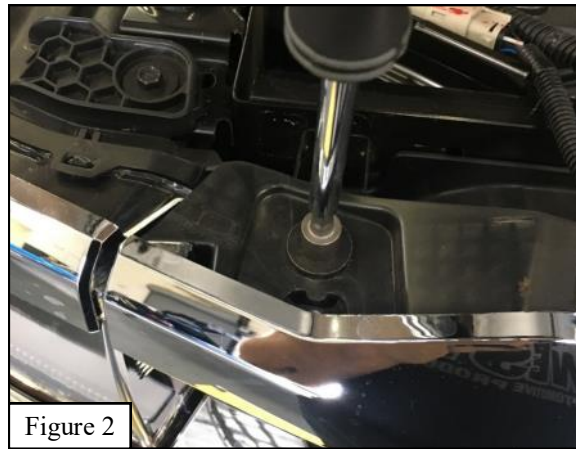

5. Pry off fenders to access the filler panel clips. See **Figure 4** for reference.
6. Pry filler panel off removing any necessary bolts. See **Figure 5** for reference.
7. Disconnect any electrical plugs and any bolts still attaching the grill to the vehicle. See **Figure 6** for reference.
8. Pry remaining clips attaching the grill to the vehicle to remove the grille.

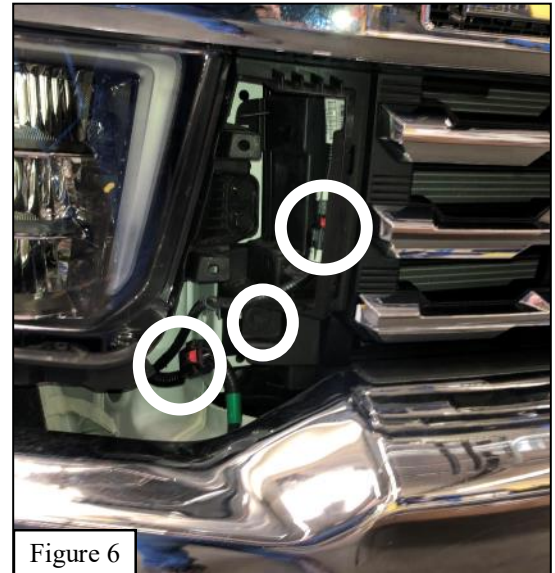
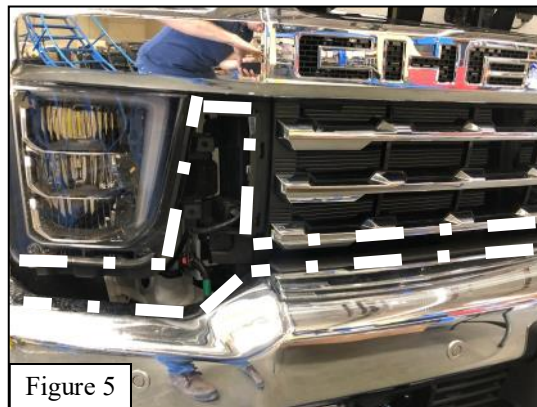

9. Remove 4 upper bumper bolts attaching the bumper to the frame and remove 2 bottom bolts attaching bumper arm to the frame. See **Figure 7 & 8** for reference.
10. Remove Bumper.

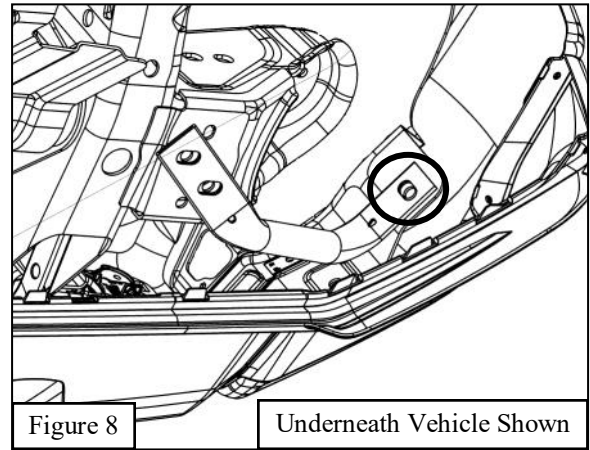
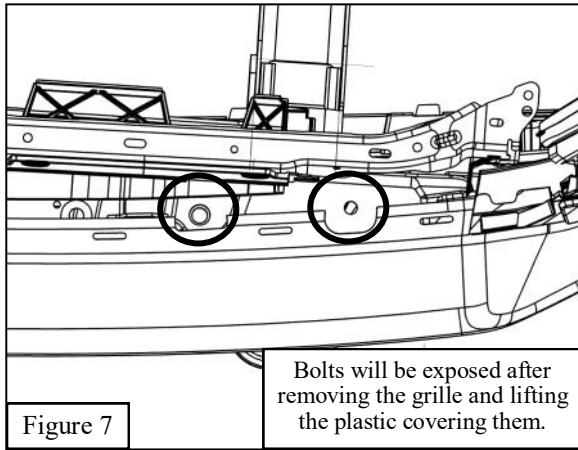

11. Locate the lower driver mounting and support brackets for the Grille Guard. Using the supplied M12 hardware, loosely install the mounting brackets on to the frame. The mounting bracket and support bracket (4-7) sandwich the frame. See **Figure 9 & 10**.
12. Repeat on the passenger side.

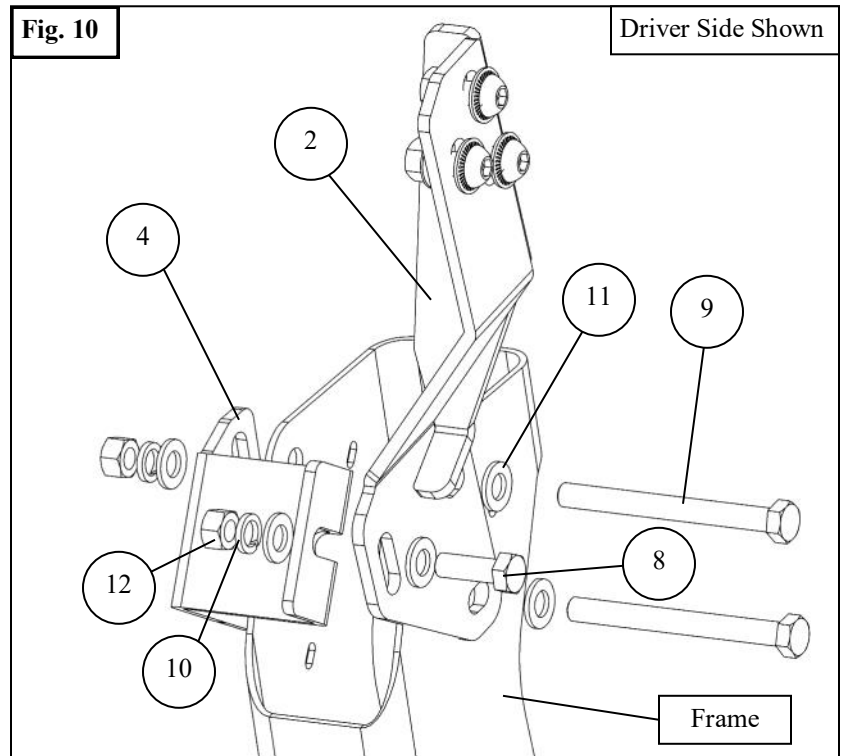
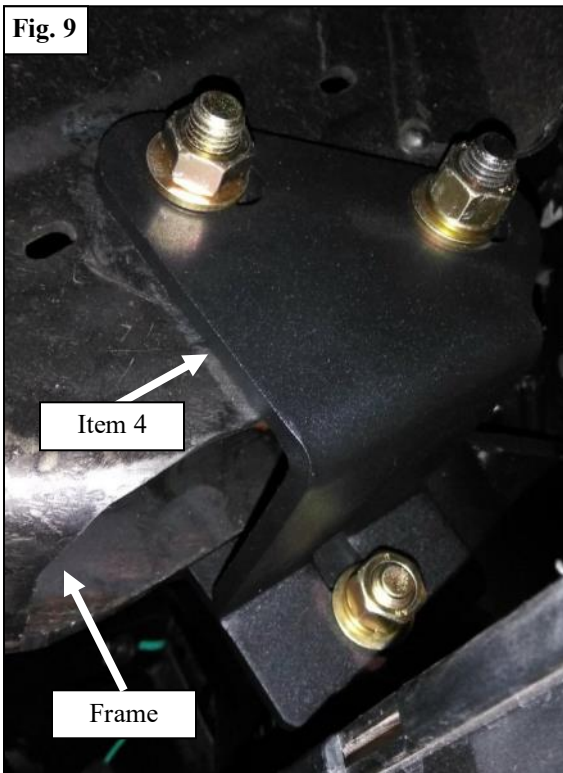

Bumper Valence Cutting Instructions 2020-2023

13. Locate the driver and passenger cutting templates (22-23). Starting on either side, along the template to the top corner of the valence. See **Figure 11**. Tape the template to the valence.
14. Using **Figures 11 & 12**, ensure that the measurements match your template. Follow the template instructions and cut accordingly.
Note: After cutting, you will still need to adjust your brackets and more cutting may be required!

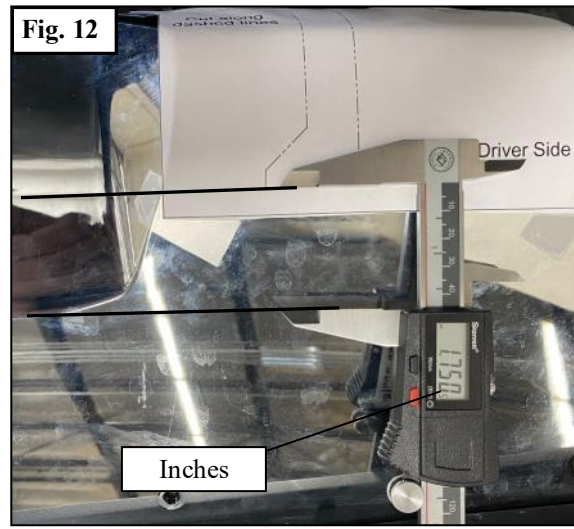
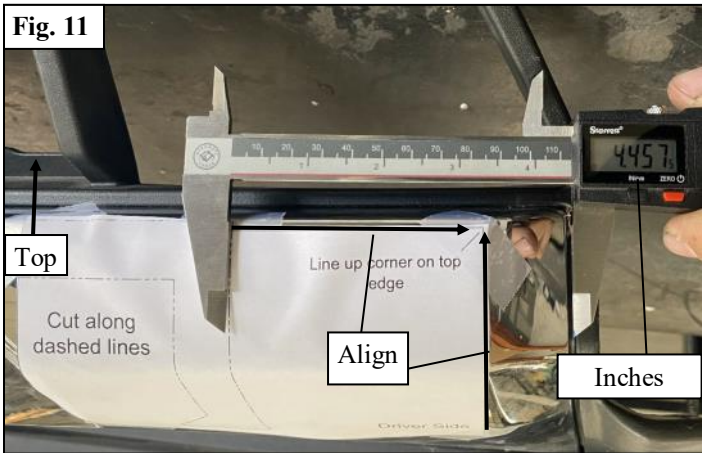

Bumper Valence Cutting Instructions 2024+

15. Locate the driver and passenger cutting templates “B” (19 & 20). Tape the driver side cutting template to the lower valence so that that the corner lines up with the edges shown below in **Figure 13**.
16. Repeat step 15 on the passenger side using the passenger cutting template “B”.
17. Using **Figure 13**, ensure that the measurements match your template. Follow the template instructions and cut accordingly.
Note: After cutting, you will still need to adjust your brackets and more cutting may be required!

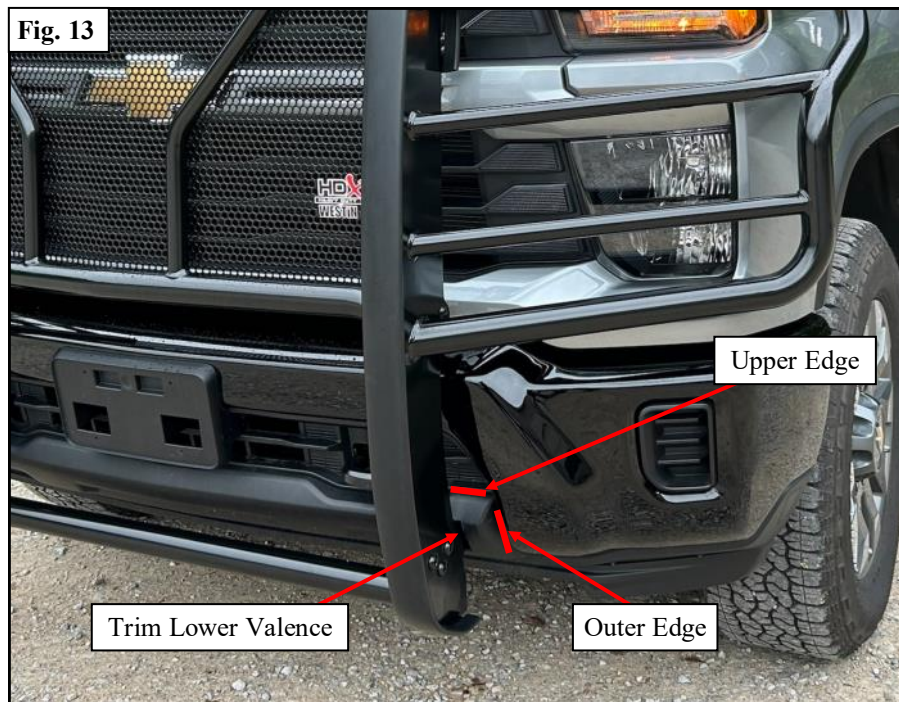

2020-2023 Upper Strap "A"

18. Locate the upper support straps "A" (6-7) for the grille guard. Loosely re-install the front bumper with the upper support straps. Reconnect all electrical connections. The upper factory bumper bolts will be used for the upper support straps. Measure the distance between the mounting surfaces of the upper straps and ensure it is about 42.25". Torque to 50-55 ft-lbs. See Figure 14 & 15.

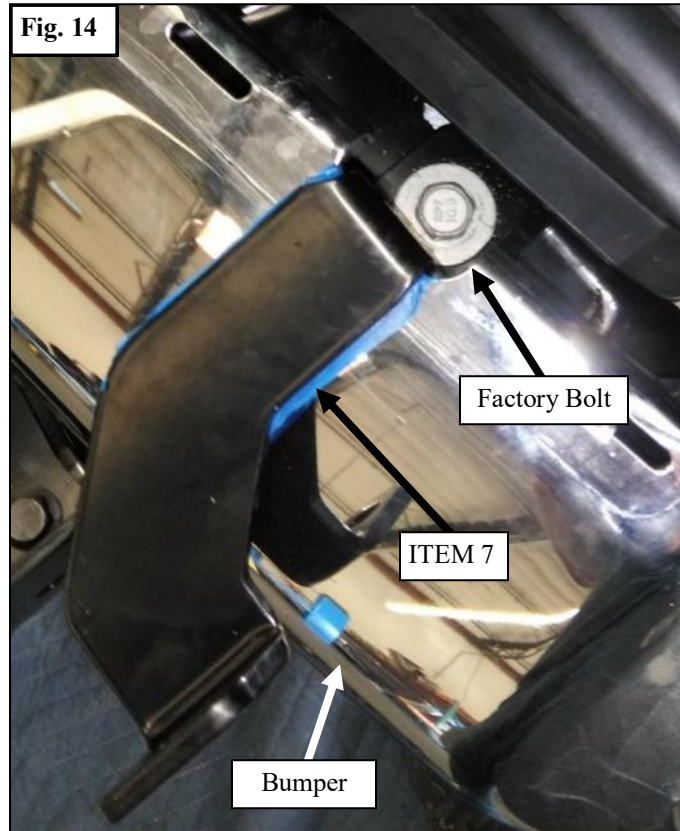
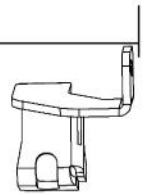

Fig. 15

42.25 inches



2024+ Upper Strap "B"

19. Remove the plastic trim shown in **Figure 16**.
20. Locate the upper support straps "B" (**items 36 and 37**). Loosely re-install the front bumper with the upper support straps "B". Reconnect all electrical connections. The upper factory bumper bolts will be used for the upper support straps.
21. Cut the plastic trim removed in Step 15 so that the bolt can be accessed. The results should look like **Figure 16**.
22. Reinstall the plastic cover. See **Figure 16**.
23. Measure the distance between the mounting surfaces of the upper straps "B" and ensure it is about 42.25". Torque to 50-55 ft-lbs.

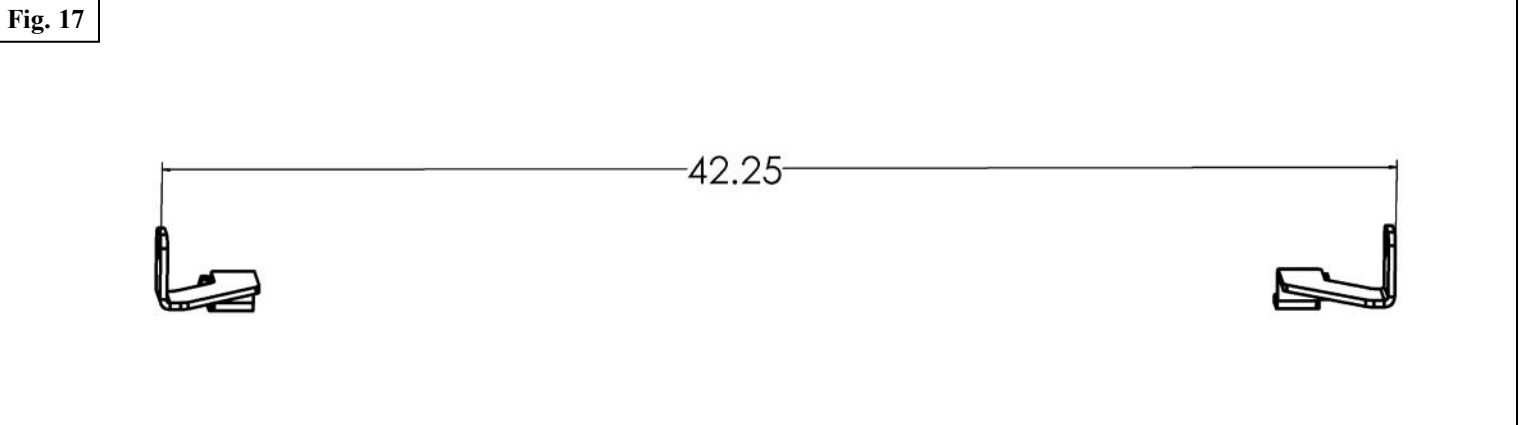

24. Reinstall the filler panel and the grille in the reverse order as instructed previously.
25. With assistance, install the HDX Grille Guard Base onto the Lower Mounting Brackets and previously installed Upper Support Straps using the supplied M10 and M12 hardware. See **Figures 18 & 19** for reference. **Note:** *The Upper Support Strap mounting location will be shared with the HDX Driver and Passenger Wings installed in Step 19.*
26. Locate and install the HDX Driver and Passenger Wings (Items 2 & 3) using the supplied M8 hardware (Items 20-22). See **Figure 20 & 21** for reference. **Note:** *The shared Upper Support Strap mounting location will use the M10 Hardware as mentioned before.*
27. Align and adjust the Modular Grille Guard assembly as necessary and torque all hardware as specified: M8 to 15-18 ft-lbs., M10 to 25-30 ft-lbs., M12 to 45-50 ft-lbs.

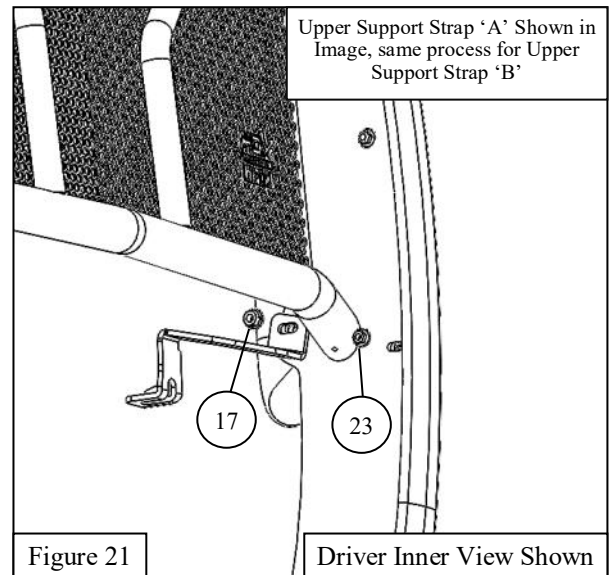
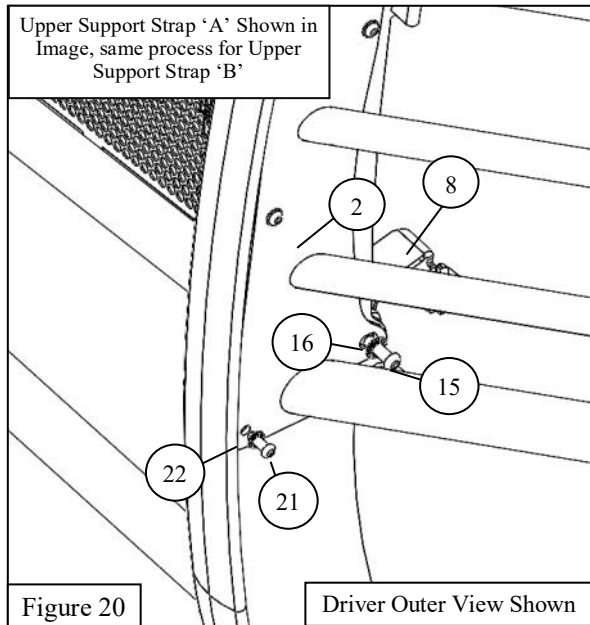
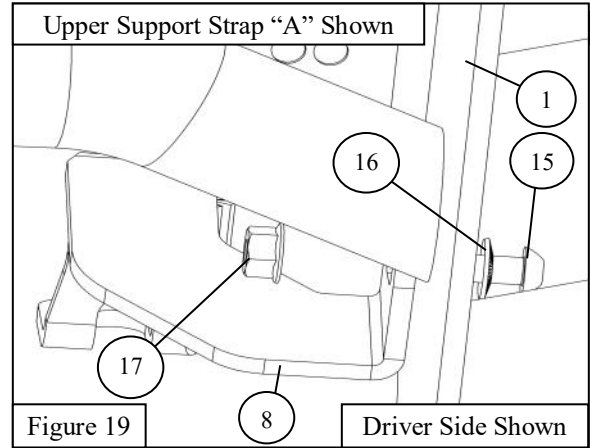
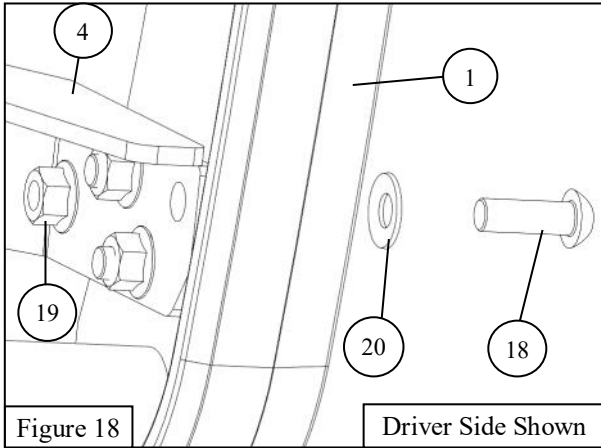

INSTALLATION COMPLETE



©2015 WESTIN AUTOMOTIVE PRODUCTS, INC. ALL RIGHTS RESERVED

CARE INSTRUCTIONS

- REGULAR WAXING IS RECOMMENDED. DO NOT USE ANY TYPE OF POLISH OR WAX THAT MAY CONTAIN ABRASIVES.
- STAINLESS STEEL PRODUCTS CAN BE CLEANED WITH MILD SOAP AND WATER. STAINLESS STEEL POLISH SHOULD BE USED TO POLISH SMALL SCRATCHES.
- GLOSS BLACK FINISHES SHOULD BE CLEANED WITH MILD SOAP AND WATER.

WESTIN Westin Automotive Products, Inc.
320 W. Covina Blvd
San Dimas, Ca. 91773

Thank You for choosing Westin products
For Additional installation assistance please call
Customer service (800) 793-7846
www.westinautomotive.com



WARNING



Failure to follow these instructions could lead to death, personal injury, and / or property damage.

Failure to follow these instructions could lead to death, personal injury, and / or property damage.

FASTENERS:

All Westin supplied fasteners must be utilized and installed in accordance with the installation instructions and apply torque to the specifications as defined. **DOUBLE CHECK ALL FASTENERS BEFORE INITIAL USE, AND PERIODICALLY IN THE FUTURE TO ENSURE PROPER FUNCTION AND SAFETY.**

DRILLING:

Most Westin products do not require drilling for installation. If drilling is defined as required, use caution when drilling a vehicle. **FAILURE TO REVIEW AN AREA TO BE DRILLED MAY RESULT IN PERSONAL INJURY AND/OR INJURY TO OTHERS AS WELL AS VEHICLE DAMAGE.**

EYE PROTECTION:

ALWAYS WEAR SAFETY GLASSES OR GOGGLES DURING THE INSTALLATION PROCESS TO AVOID PERSONAL INJURY.

MAXIMUM TOWING/CARRYING CAPACITY: (if applicable)

The Westin Receiver Hitches will have a visible tow rating label affixed directly on the product. User should never exceed the vehicle manufacturers maximum tow and weight rating regardless of the capacity of the hitch. **FAILURE TO FOLLOW THESE GUIDELINES WILL VOID THE WESTIN WARRANTY AND MAY RESULT IN PERSONAL INJURY AND/OR INJURY TO OTHERS AS WELL AS VEHICLE DAMAGE.**

FOR CALIFORNIA RESIDENTS ONLY-PROP 65 WARNING:

Some products may contain chemicals such as DEHP, which can cause cancer, birth defects or other reproductive harm. For more info go to www.p65warnings.ca.gov